

## Group-1 ID Numbers And Frequencies

A Group-1 receiver can accept frequencies and ID numbers from a T5000E, T9000E or RF1300 wireless throttle. Burst mode is supported for only the T5000E.

Every throttle using a Group-1 frequency must have a unique ID number within the range of 1 to 8. You should record the ID number somewhere on the throttle for easy reference. The T5000E and the T9000E will show you their current ID number.

If a Group-1 receiver receives an incorrect ID on a Group-1 frequency, the receiver's red CD light will turn on and the GP light will be off. You must find the improperly set throttle and change it to stay within the ID range of 1 to 8.

Group 1		Scan Mode			Burst Mode		
Freq #	Freq MHz	T5000E	T9000E	RF1300	T5000E	T9000E	RF1300
0	903.37	Yes	Yes	Yes	Yes	No	No
1	906.37	Yes	Yes	Yes	Yes	No	No
2	907.87	Yes	Yes	Yes	Yes	No	No
3	909.37	Yes	Yes	Yes	Yes	No	No
4	912.37	Yes	Yes	Yes	Yes	No	No
5	915.37	Yes	Yes	Yes	Yes	No	No
6	919.87	Yes	Yes	Yes	Yes	No	No
7	921.37	Yes	Yes	Yes	Yes	No	No

## Group-2 ID Numbers And Frequencies - T5000E Only

The Group-2 receiver is usable only with the T5000E throttle (or later models). The Group-2 ID numbers are from 9 to 16.

The Group-2 frequencies are not usable with older T9000E, RF1300 or TX904 wireless throttles.

Every throttle must have a unique ID number within the range of 9 to 16.

If a Group-2 receiver receives an incorrect ID on a Group-2 frequency, the receiver's red CD light will turn on and the GP light will be off. You must find the improperly set throttle and change it to stay within the ID range of 8 to 15.

Group 2		Scan Mode	Burst Mode
Freq #	Freq MHz	T5000E ONLY	T5000E ONLY
8	904.87	Yes	Yes
9	910.87	Yes	Yes
10	913.62	Yes	Yes
11	916.87	Yes	Yes
12	918.12	Yes	Yes
13	923.12	Yes	Yes
14	924.62	Yes	Yes
15	926.12	Yes	Yes

## Replacement Parts

Whip antenna with UFL connector..... \$ 6.00

## XF-Series Wireless Receiver Installation Instructions

### EASYDOG – System 6 Software

For Group-1 or Group-2 XF-Receivers

**NEW**



There are many ways to setup and hookup your wireless receiver to achieve best performance. For now, if you only have a couple of wireless throttles, set the receiver for what is called SCAN-8.

Don't Leave Batteries In Your Throttles! Run down batteries can cause damage to the throttle or other problems. If in doubt, remove the batteries.

Wireless throttles must be set to the correct range of ID numbers for this receiver. If an incorrect ID number is received, the CD light will turn on.

**Antenna Must Be Exposed**  
The antenna must be unpacked and rotated vertical before using the receiver. See below for how to do this.

## First Things First - Unpack The Antenna

Your receiver comes with a small flexible antenna that is shipped underneath the top of the chassis. Before installing the receiver, you must open up the chassis and rotate the antenna upwards so that it is vertical and sticking through the small hole in the chassis top. It takes just a couple of minutes. You will need a phillips screwdriver.

Turn the chassis upside down. Remove the two screws holding the two halves of the chassis together. Turn the chassis right side up and gently lift off the top. The rear panel is floating so it may or may not come out. If it does come off, just slip it back in place using the slots on the sides and bottom.

Use your fingers to rotate the small gold connector attached to the small clear plastic covered antenna so that it is vertical. The antenna connector snaps onto the module. If it has come off, just snap it back on.

To reassemble, place the lid with the stamped writing on its flip side towards the rear of the chassis and the small hole towards the front panel. Thread the antenna through the small hole in the lid. Don't use the center hole - it is reserved for a different antenna. Reattach the screws. Take care not to kink or bend the whip. It must be vertical for best operation.

## Group-2 Frequencies Only For T5000E Throttle

The Group-2 frequencies are usable only with a T5000E throttle or later mode. It cannot be used with older wireless throttles.

The Group-2 receiver operation, the switch settings and the hookup instructions for a Group-2 receiver are the same as for Group-1 receiver.

Group-2 frequencies can only be used with Group-2 ID numbers. The list of frequencies and ID numbers for both types of receivers are on the back page.

*A Group-1 receiver can be used with a T5000E, T9000E, or RF1300 wireless throttle providing the older throttles are not using burst mode.*

©2014 CVP Products P.O. Box 835772 Richardson, TX 75083

All Rights Reserved - May Not Be Duplicated Or Copied Without Permission

## Basic Hookup - Receiver Direct To Command Station

This is the simplest and most basic hookup of the wireless receiver. This setup allows the receiver to scan for up to 8 different throttles on its 8 available frequencies. It connects directly to the Command Station with the included 7 foot modular telco cable. The absolute maximum length of the modular cable is 14 feet. Exceeding this range can result in poor receiver performance or simply no operation of the receiver. Do not use a "data" style modular cable. It will not work.

The receiver's power supply is the included 12VAC transformer.

### Receiver Setup Switch Settings

The setup switches need to be all off except for switch number 6. It must be up in the "ON" position. Use a pencil, pen or small screwdriver to slide the white actuator up to the top of the slot.

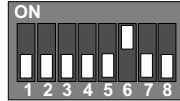

### Always set or change the receiver's switches with the power off.

Plug one end of the modular cable into the receiver's socket. The cable's other end plugs into the Command Station's socket labeled TBUS. On the latest CS2B model of the Command Station, it will be the left most socket when viewing the back of the Command Station. For older model Command Stations, see its Installation Manual, "The Orange Book," to locate the proper socket. The older Command Stations have the modular sockets in different locations.

**Do not accidentally plug the modular cable into the wrong Command Station socket.**

When plugging the cable into the socket, do not force it. The plug will insert easily and lock with an audible click. To release the plug, push down on the cable plug's little plastic tab and gently pull the cable out of the socket. This concludes the basic receiver hookup and switch setup.

### Throttle Setup and Requirements

- ☑ Up to 8 different throttles can be used simultaneously.
- ☑ Each wireless throttle will use one of the 8 frequencies.
- ☑ Only one throttle is allowed per frequency.
- ☑ Each throttle must have a unique ID number in the range of 1 to 8.
- ☑ No duplicate ID numbers are allowed.

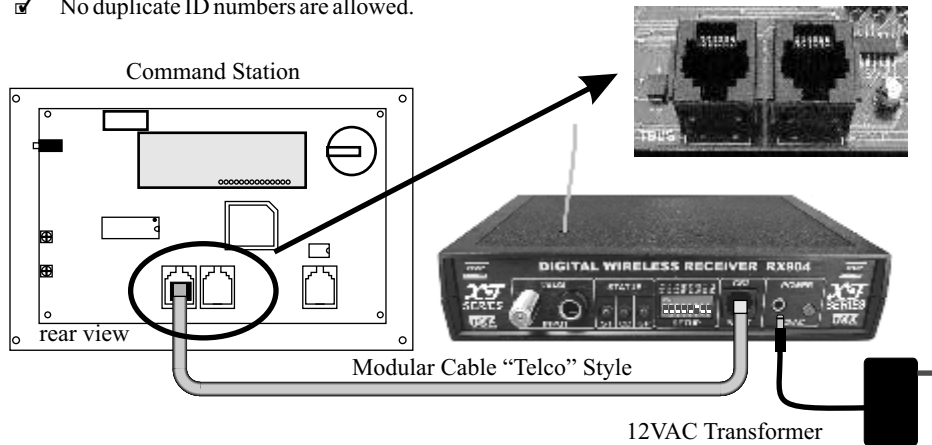

## Indicator Lights

The **GP LED** turns on when a throttle, with the correct ID and using one of the 8 available frequencies, is being received. The GP LED will normally flash or blink while it is receiving signals from a wireless throttle which is normal.

The **CD LED** turns on whenever an out-of-range ID number on a throttle is received.

The **ST LED** is on whenever the wireless receiver is polled by the Command Station. This LED may flicker depending on the number of throttles in use. This is normal.

## Summary Of Switches And Setting Options

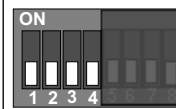

**Default Scan Setting - All 8 Frequencies Are Scanned:** All 8 of the available frequencies are scanned. The available frequencies are based on if receiver is Group-1 or Group-2. The back page lists the frequencies.

Note: The gray shading over some of the switches indicates that they are not involved in setting up the frequencies or actions described.

### Frequency Lockout Switches - Used During Scan Mode To Ignore Selected Frequencies

The gray shading over some of the switches indicates that they are not involved in setting up the frequencies or actions described. Frequency-0 is abbreviated F0, Frequency-1 is abbreviated F1, etc.

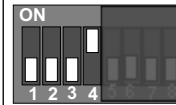

**SCAN-1 Frequency Only:** Only a single frequency can be received. The frequency is selected using the switches 1, 2 and 3. These settings are settings shown below. From the table, this setting allows only frequency 7 to be received. All other frequencies are ignored.



**SCAN-2 Frequencies Only:** Frequencies F0 and F1 are scanned. All other frequencies are ignored.

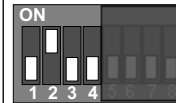

**SCAN-4 Frequencies Only:** Frequencies F0, F1, F2, F3 are scanned. All other frequencies are ignored.

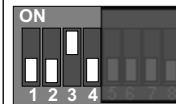

**SCAN-6 Frequencies Only:** Frequencies F0, F1, F2, F3, F4, F5 are scanned. The other two frequencies, F6 and F7 are ignored.

### Frequency Selection Switch Settings - Actual Frequency Depends On The Group Number



Frequency-0

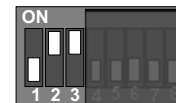

Frequency-1

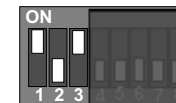

Frequency-2

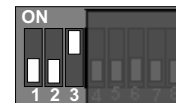

Frequency-3

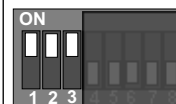

Frequency-4

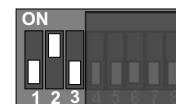

Frequency-5

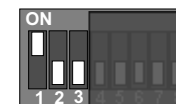

Frequency-6

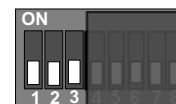

Frequency-7

### Hookup Options

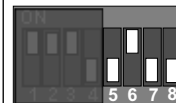

Modular Cable

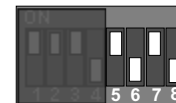

Coaxial Cable  
No Termination

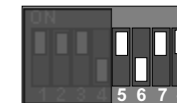

Coaxial Cable  
With Terminator  
Resistor **ON**

## Record Keeping - Before You Contact Us For Help

If after trying all of our troubleshooting and placement suggestions, and still have difficulties, please contact us. Email is better but you can also give us a call. Before contacting us, please collect the basic information below so we can help you better.

### Why We Need This Information - And So Do You

The majority of operational issues with wireless equipment is incorrect settings, modes or hookup. Many times, a customer has told us he figured out his problem while collecting this information. This continues to validate our number 1 assumption about the cause of a problem - it's always something simple! You should keep this information in a handy place. You might remember next week, but what about next month or next year?

### Command Station Information - Very Important

On the home page of your Command Station, the top line contains 3 important numbers we need to know. First, note the V-number which is the software version number. The T-number stands for the number of active throttles. This is not as important for us but you should record that number too. At the far right is the M-number which is the memory counter indicating the remaining free locomotive slots. Write your numbers in the space provided and be sure and include them when contacting us.

```
V6xx T=00 M=255
A=0003 B=-----
```

V \_\_\_\_\_

T \_\_\_\_\_

M \_\_\_\_\_

### Wireless Receiver Hookup and Switch Settings - Very Important

For each receiver, we need to know the model number, its group, how it is connected to your Command Station, and the settings of the 8 switches. As for model number, if it has a metal rod antenna or a black wire antenna in the center of the lid, it will be a standard RX904. However, if it has an antenna down in the lower left front of the lid, and has the stylized XF on the faceplate, that is the RX904-XF(1 or 2) model. For all receivers in use, fill out the blanks with the information. The hookup method is either coax or modular. Note: XF-1 is a group 1 receiver; XF-2 is a group 2 receiver.

Receiver Model \_\_\_\_\_  
Receiver Group \_\_\_\_\_  
Hookup Method \_\_\_\_\_

Switch Settings →  
Show the actuator position as either up or down.

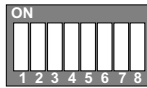

Receiver Model \_\_\_\_\_  
Receiver Group \_\_\_\_\_  
Hookup Method \_\_\_\_\_

Switch Settings →  
Show the actuator position as either up or down.

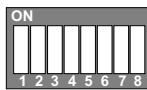

Receiver Model \_\_\_\_\_  
Receiver Group \_\_\_\_\_  
Hookup Method \_\_\_\_\_

Switch Settings →  
Show the actuator position as either up or down.

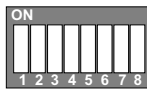

### Wireless Throttle Information - Very Important

For each of your wireless throttles in use, we need to know the model (T5000E, T9000E or RF1300). We also want to know each of their ID numbers, their scan/burst mode setting and their frequency. Use the table below to record the information. See your throttle user guides for how this

Model	ID#	Freq	Mode	Model	ID#	Freq	Mode	Model	ID#	Freq	Mode

## Adding Receiver At The Extender's Modular Cable Output

This is another simple setup in which the modular telco cable plugs into the Extender's modular cable jack labeled OUTPUT. This is a common hookup where you already have an Extender in use for plug-in throttles and want to add a receiver next to the Command Station.

The same cable limitations have to be met as with a direct hookup to the Command Stations. The absolute maximum length of the modular cable is 14 feet. The length is the sum of the modular cable between the Extender and the Command Station, plus the length of modular cable between the Extender and the Receiver. Exceeding this range can result in poor receiver performance or simply no operation of the receiver. Do not use a "data" style modular cable. It will not work.

This setup allows the receiver to scan for up to 8 different throttles on its 8 available frequencies.

The receiver's power supply is the included 12VAC transformer.

### Receiver Switch Settings

The setup switches need to be all off except for switch number 6. It must be up or "ON." Use a pencil, pen or small screwdriver to slide the white actuator up to the top of the slot.

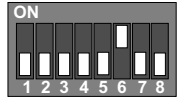

Set or change the switches with the power off.

Plug the modular cable into the Extender's socket SK3, labeled OUTPUT. Plug the other end into the Receiver.

When plugging the cable into the socket, do not force it. The plug will insert easily and lock with an audible click. To release the plug, push down on the cable plug's little plastic tab and gently pull the cable out of the socket.

This concludes the basic receiver hookup and switch setup.

### Throttle Setup and Requirements

- Up to 8 different throttles can be used simultaneously.
- Each wireless throttle will use one of the 8 frequencies.
- Only one throttle is allowed per frequency.
- Each throttle must have a unique ID number in the range of 1 to 8.
- No duplicate ID numbers are allowed.

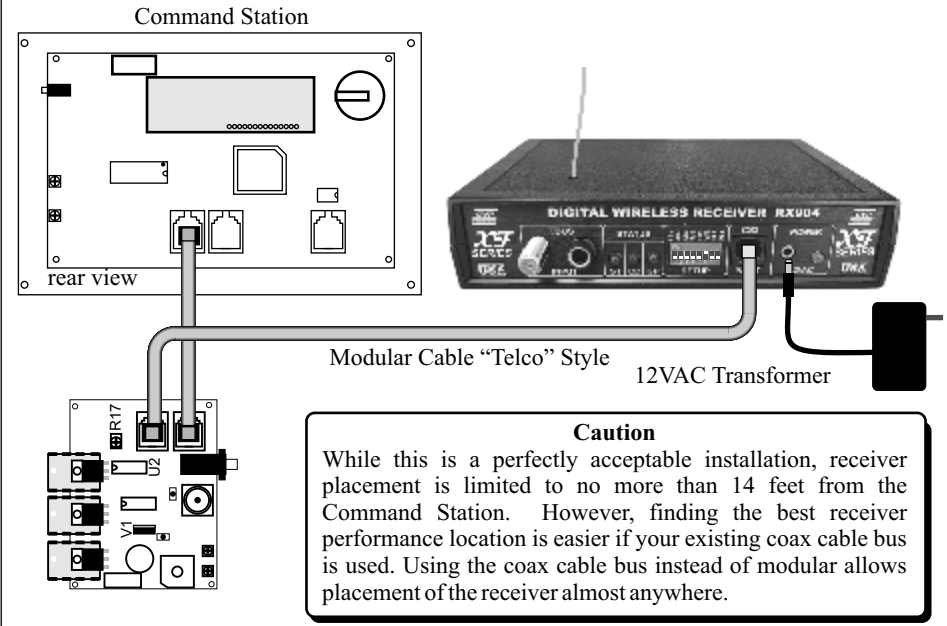

## Adding Receiver To Existing Plug-In Throttle Bus

This hookup diagram assumes that you are adding a wireless receiver somewhere along an existing coaxial TBUS throttle bus. Pick from one of the two installations based on how far the receiver is from where it will connect to the throttle bus, either somewhere along the run or at the end of the coax run.

If the receiver is close to an existing plug-in throttle fascia plate, just solder a 3rd F-Jack into the holes on the circuit board. F-jacks can be purchased from CVP Products. The receiver must not be at the end of the coax run. If its at the end of the run, see the next section.

If the desired location is further than a few feet from a fascia plate, install a Fascia-Tee board, also available from CVP. This is nothing more than a fascia circuit board without the 1/4 inch throttle jacks. Cut the coax and use standard twist-on connectors to connect the two ends to the new Tee board. The third jack connects to the receiver.

Maximum length for the coax is about 3 feet. Any longer and the signal becomes distorted and unusable by the Command Station.

### Receiver Switch Settings

Turn on switches 5 and 7. All other switches must be off. This setup allows the receiver to scan for up to 8 different throttles on its 8 available frequencies and communicate back to the Command Station by way of the coax cable.

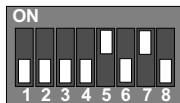

Set or change the switches with the power off.

### Throttle Setup and Requirements

- ✓ Up to 8 different throttles can be used simultaneously.
- ✓ Each wireless throttle will use one of the 8 frequencies.
- ✓ Only one throttle is allowed per frequency.
- ✓ Each throttle must have a unique ID number in the range of 1 to 8.
- ✓ No duplicate ID numbers are allowed.

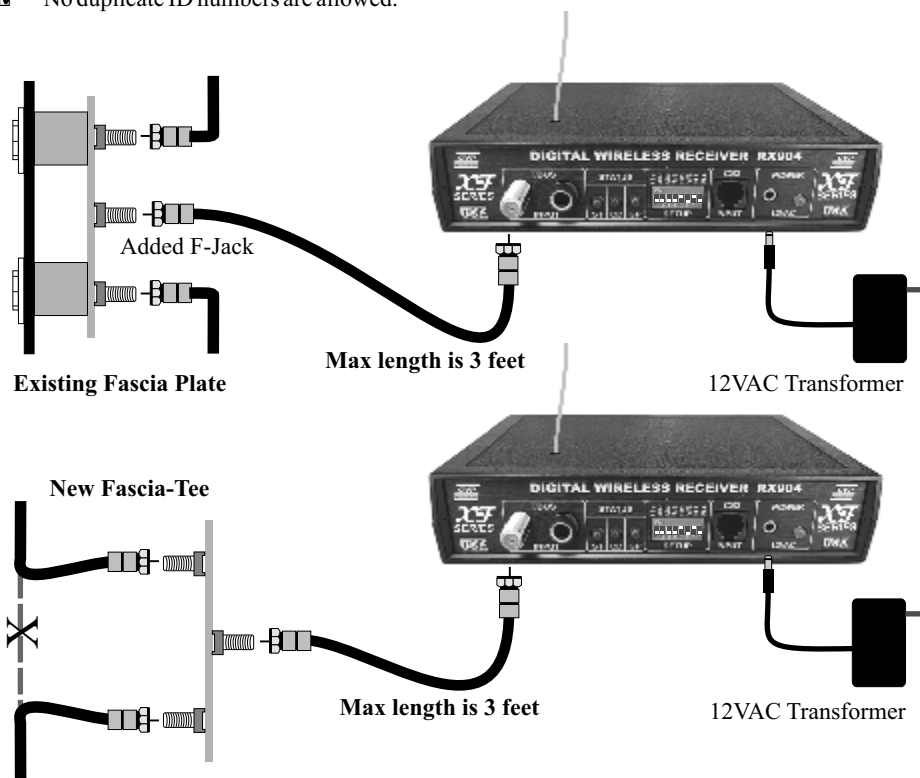

## Monitoring A Throttle At The Command Station

At any time you can monitor the speed, direction, and function status of any active throttle by using its current locomotive number and the SHOW LOCO feature on the Command Station. This is a handy tool if you suspect some kind of throttle problem.

The SHOW LOCO SPEED command will always tell you what current speed and direction command is being sent to an active locomotive address. This is handy if you suspect a bad throttle. Just use the address of the throttle in question. The display will show you exactly what is being received from the throttle. If nothing appears, then the throttle is not assigned to the address you think it is or there is something wrong with the throttle.

For the example below, a wireless throttle is controlling loco address 5321. On the Command Station push to following keys in sequence:

- SHOW, ○ LOCO,
- 5, ○ 3, ○ 2, ○ 1, ○ ENT,
- SPEED



This display shows several items pertaining to locomotive 5321. The first line is the speed and direction currently being received from the throttle. "000%" is the current percentage of full speed; 000 is off, 100% is full speed. The F in front of the speed percentage says the direction command is set to forward. The bottom line shows the current status of the decoder's functions as set from the throttle. Each square represents a function starting at F0 and going up to F12. Open square means the function is OFF. A dark square means the function is ON. For this locomotive, the headlights F0 are on, F0, and the bell is ringing since it was assigned to F3.

- ESC Pushing ESC returns to the home page.

### If You See Dashes Instead of Percentage

A loco address will have xxx in place of the speed percentage if the wireless throttle has temporarily lost contact with the receiver or if there has been no throttle activity within the past two minutes. xxx also appears if the specific loco address is currently assigned to a consist.

## Checking RF1300 Throttle ID

Many times, we are sent an RF1300 throttle for repair with the complaint that it doesn't work. Assuming there isn't an issue with battery leakage, the most common cause of non-operation is an incorrect ID number. Since there is no display, checking the RF 1300 throttle ID number requires the use of the Command Station and the SHOW ID function. Of course, you can also just give it a new ID number and not worry about what it is - simply set it for what you want.

The technique works on only one throttle at a time. The Command Station needs to be reset before checking another. Be sure to turn on the RF1300 throttle and wait for about 2 minutes. On the Command Station, push the following keys, one at a time, in the sequence shown. For this example, the ID is 6 and the throttle is set to run loco 1.

- SHOW, ○ ID (the 8 key),

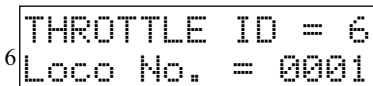

This display shows the the RF1300 throttle is set to ID 6 and is controlling loco address 1.

- ESC Pushing ESC returns to the home page.

### If You See Nothing After ID And The 2nd Line Is Blank

This says the ID is not within the allowed range of the receiver. It could also mean the throttle is set to the wrong frequency or the throttle is set to the wrong mode. All of these causes means the throttle is not set up correctly and is not faulty. See the RF1300 user guide for how to properly set the ID and the frequency.

## Adding Another Group - More Frequencies

With a Group-1 Wireless Receiver, up to 8 throttles can be used at the same time. To go above 8 throttles, add a Group-2 Wireless Receiver. With the new Group-2 receiver, 8 more unique frequencies become available. Together, the combination of a Group-1 and a Group-2 receiver allow up to 16 wireless throttles to be used simultaneously and without interference. Every throttle has its own unique frequency which is not shared with any other throttle.

### Only The T5000E Throttle Can Use The Group-2 Wireless Receiver

The T5000E can use any of the 16 frequencies on either the Group-1 or the Group-2 receiver. Your older throttles such as an RF1300 or T9000E, must use a Group-1 receiver and must not use burst mode.

### Combining Old And New Receivers

Your older RX904 receivers can still be used as is. But, if you also have an older receiver that is set for Group-2, it can no longer be used. The ID numbers for group-2 have been assigned to the new Group-2 receiver which will only work with the T5000E throttle. Consider upgrading the older receiver to the new radio and software.

### Hookup Of Group-2 Receivers

The Group-2 receiver is no different than the Group-1 receiver. The switch settings are the same and any of the hookup options can be used. For best results, use the coax cable bus for hookup.

## Troubleshooting Guidelines

### Symptom: Intermittent loss of loco control

Cause: Most common cause is receiver not getting the throttle signal. There are many possible reasons for this. Most of the causes are discussed in the receiver placement guidelines section.

Solution(s): Receiver placement change and/or additional receivers to cover weak reception areas.

### Symptom: A normally running loco begins to stutter, hesitates or runs poorly

Cause: The most common cause of this is that there are two throttles attempting to control the same locomotive. This usually happens when a wireless throttle which was controlling the loco is turned off and another throttle is then used to control the same loco. The receiver doesn't know the difference between the a throttle that has temporarily gone out of range or a throttle that is turned off. In either case, the receiver will continue to send updates for speed and direction to the loco address for several minutes. Thus when the new throttle selects the same loco address, the receiver is now sending the old throttle's information plus the new throttle's information to the same loco address. Thus two throttles are trying to control the same loco address.

Solution: This is an easy one - assign the throttle to a phantom address before turning it off. First pick an unused address that is easy to remember. Examples are 1 or 99 or 9999. It can be any address, but it should not be one that is actually assigned to a locomotive. Instruct all operators to set the throttle to this address before turning it off.

### Symptom: Throttle has poor loco control

Cause #1: Usually this is caused by two throttles with the same ID number.

Solution: Inspect all throttles, wireless and plug-in, to make sure every throttle has a unique ID number.

Cause #2: Throttle is set to incorrect transmission mode.

Solution: Set throttle to scan mode. Do not use burst mode. See throttle manual for how to set this.

### Symptom: A throttle, when turned on, causes interference with another throttle

Cause #1: Two throttles are on the same frequency.

Solution #1: Make sure every throttle is on a unique frequency.

Cause #2: Throttle is set to incorrect transmission mode

Solution #2. If frequency 7 is affected, one of the wireless throttles is set to burst mode. Burst mode will jam frequency 7. Do not use it.

## Adding Receiver At The End Of The Coax Throttle Bus

This hookup diagram assumes that you are adding a wireless receiver to an existing TBUS plug-in throttle bus. This hookup diagram is for use when the receiver is at the end of the throttle bus run.

For this hookup, you must remove the existing 75 ohm terminating resistor soldered to the last fascia plate at the end of the coax cable run. Instead, you will use the terminating resistor built into the receiver.

Once the old terminating resistor has been removed, attach the coax cable to the fascia-plate F-jack and the F-jack on the receiver. The overall length of the entire length of coax should be no more than about 100 feet for RG58 or RG59 coax. If you have used RG6, the total overall length can be twice as long.

### Receiver Switch Settings

Turn on switches 5, 7 and 8. All other switches must be off. This sets the receiver to scan for up to 8 different throttles on its 8 available frequencies and communicate back to the Command Station by way of the coax cable. It also uses the receiver's built-in line terminator.



Set or change the switches with the power off.

### Throttle Setup and Requirements

- ✓ Up to 8 different throttles can be used simultaneously.
- ✓ Each wireless throttle will use one of the 8 frequencies.
- ✓ Only one throttle is allowed per frequency.
- ✓ Each throttle must have a unique ID number in the range of 1 to 8.
- ✓ No duplicate ID numbers are allowed.

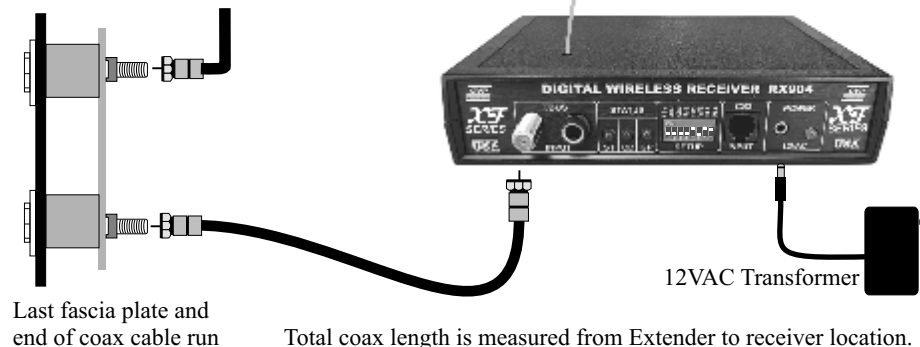

### WARNING

Never use any type of inline amplifier, TV splitter or TV "Y" adapters. They will not work and may damage the Extender.

## Improving Coverage - Using Multiple Receivers

While using wireless throttles you may find a distant location where the throttle no longer controls the locomotive or the locomotive functions commands become intermittent. This is usually caused by what we call a black hole - an area where the receiver can't "hear" the throttle's transmissions. There is a long list of potential causes that are detailed in the section titled: Receiver Placement Suggestions.

Regardless of the cause of the black hole, the most common and simplest solution is to try relocating the receiver first. We are amazed at how many receivers have never been moved from their very first "temporary" location. Sometimes a foot or so in any direction is all it takes to radically alter the reception pattern. Sometimes it is better to move the receiver closer to the center of the layout. Sometimes, placing it in the ceiling is better. So before spending money on more receivers, why not first try different locations. The best way to do this is to use the coax throttle bus.

### Switch To The Coax Throttle Bus

Once you have decided to move the receiver, you need to switch to using the coax cable hookup. Using the coax allows the throttle to be moved anywhere without regard to distance. Attach the receiver to a 100 foot length of coax and try out different locations. You may find one location that works best and that is where you should mount the receiver permanently. However, if you don't find a single location that has good reception from distant throttles, then you need to add another receiver that favors the distant location.

### Adding Another Receiver

If you are using a Group-1 Receiver, then you will need another Group-1 Receiver. If you are using a Group-2 receiver, then get another Group-2 receiver. It is mandatory that both receivers are of the same type and Group.

### Receiver Switch Setting

Since both receivers will be attached to the coax throttle bus, they will have exactly the same switch settings. Switches 5 and 6 must be ON when using the coax jack.



If one of the receivers will be at the end of the coax cable, then it needs switch 8 turned ON in addition to 5 and 6. Switch 8 is the terminator for the end of the line. Remember, only one terminator can be used.

### Using Heavy Duty Coax - RG6

Very large layouts or layouts in widely spaced rooms may need to use another wireless receiver in a remote area to provide adequate reception. If the distance is more than 100 feet, you must use RG6 coaxial cable. Smaller cable will have too much voltage loss.

### Using Multiple Extenders

Although not required, a receiver can have its own dedicated Extender. On many large layouts, owners have an Extender for their XR1300 Plug-In throttles and a separate Extender for their wireless receiver. The Extenders connect together from output to input. Except for the first extender, R16 must be clipped from each additional Extender. Also, up to 3 Extenders can share the same AC transformer. And since all Extenders need to be next to the Command Station, you need to keep the modular cables short. Custom length cables are available from CVP.

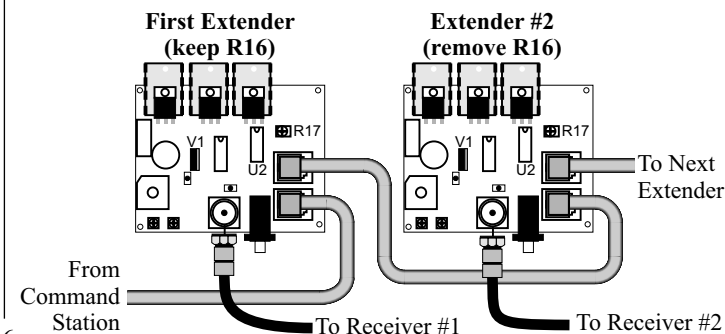

**Modify Extender**  
Except for the first Extender, all additional Extenders must have R16 clipped out for proper operation.

## Receiver Placement Guidelines

Every layout environment is different. Therefore we recommend an extended period of trial and error receiver placement. Note: always hold the throttle so its antenna is vertical and don't place your hand near the top of the throttle box where the antenna is located.

**Keep all material and objects** away from the receiver's antenna, especially metallic objects.

**Human bodies will affect reception patterns and absorb radio energy.** Consider experimenting with receiver location when the normal number of operators are present.

**Higher is generally better.** Rafter installations, especially in basements, seem to be better than the floor. But we've also had a report that lower is better; you should always try both.

**Keep it away from areas of high concentrations of throttles.** Pick a spot away from an area that will have a heavy concentration of wireless throttles. A nearby wireless throttle can swamp out the receiver preventing a distant throttle from being heard.

**Use the lowest throttle power setting possible.** For T5000E throttles that are always near the receiver, use a lower power level.

**Always test multiple locations.** To test a location, temporarily set the receiver the test location. Then walk the layout with a SINGLE throttle that is set for a decoder with a good loud horn or whistle. Push the F2 key to sound the horn. If you can hear the horn responding to F2 commands no matter where you are on the layout, you've found a fairly good spot for the receiver.

**A new location can be as close as 1 foot.** In many cases a move of less than 1 foot in any direction, can make a dramatic difference in reception. After a weak area has been identified, move the receiver towards the weaker area. If you find a chronic weak area, consider adding a second receiver to provide additional coverage in the weak area.

**AC lamp dimmers can sometimes jam a receiver.** These devices emit a broad spectrum of interfering radio signals and can sometimes jam the receiver. If you have a lighting system like this, consider not using it or equipping it with UL approved line filters.

**Keep the receiver antenna away from fluorescent lights.**

**Train your operators** to recognize when the receiver has lost contact or "dropped" the wireless throttle. The command station can not tell the difference between a "dropped wireless throttle" or a wireless throttle that has been turned off. The locomotive either keeps moving or it never starts moving because the receiver can not "hear" the wireless throttle. This can cause some interesting problems if your operators are not trained. Here's an example:

Assume the operator has just stopped the train for a red signal. The signal clears and the operator sets the speed control to the 11:00 position but the train doesn't move. What do 99.9% of the people do at this point? That's right - they turn the speed control higher! Wrong thing to do! The moment they shift their physical position a few inches, the receiver will pick up their signal, and the train roars off at high speed! A trained operator leaves the speed control alone and just moves his body position by a foot or so. In almost all cases, the receiver will see the signal. Just like your cell phone, if you are experiencing a large number of dropped commands from wireless throttles, you should add additional wireless receivers to improve reception.

**Don't use surplus power supplies,** especially the high-tech switching supplies are appearing on many railroads. These supplies tend to be very inexpensive for the amount of power they provide. However, these surplus supplies also emit a broad spectrum of interference and can sometimes jam one or more of the wireless throttle's frequencies. Try turning off the power supply to check if it is the cause of interference. If it is, the power supply should be replaced.

**Beware of other non-railroad wireless equipment that could jam a receiver.** The EasyDCC throttles and receivers operate in an unlicensed band shared by many other wireless systems. These systems can and do create jamming interference which can make some frequencies unusable. Examples include wireless devices attached to computers, TV remote controls, cordless telephones, wireless alarm systems, baby monitors, personal communication devices, lawn sprinkler and outdoor lighting controllers, cordless light switches, toys/games, wireless headphones and speakers. The list grows longer every Christmas season.