

What do I need to get started with AIRWIRE? (Also see page 3)

First: An AirWire900 decoder for your locomotive. When considering which locomotive on which to do your first installation, pick a locomotive that is large with plenty of internal space. The easiest locomotive decoder to install will be the Drop-In or the Plug-In style.

Second: An AIRWIRE900 handheld throttle. The T5000 must be your first throttle since it is also used to setup all AirWire decoders.

Third: a battery and a battery charger. Think about where you will put the battery. Some users, prefer using dummy locomotives or freight/passenger cars to hold the battery packs. Placing batteries in trailing cars makes it easy to swap out a depleted battery for a fresh battery.

Optional Add-ons: You may also add an optional sound module from any of the suggested compatible vendors. It is easier and quicker to install sound while installing the locomotive decoder although the sound option can be added at any time.

Where do I purchase AIRWIRE?

You may purchase from any of our authorized dealers or you may purchase directly from CVP Products. See the CVP Products website for the dealer listing. You can also download an order blank or give us a call to place your order.

How difficult is AIRWIRE to install?

Installing an AIRWIRE decoder isn't really a hard, or complicated task. For USA-Trains locomotives, the Drop-In decoder is designed for easy installation using existing locomotive wiring and connectors. The G3 decoder is smaller and has terminal blocks for easy hookup. No special tools are needed although a small soldering iron is necessary. If you would rather have somebody else do the installation, see the AIRWIRE dealer listing on the CVP website. Most of them offer installation services.

Will AIRWIRE fit smaller scales like O or HO? (Also read page 4)

Surprisingly, YES! The only difficult part is figuring out how big of a battery can be used and where to put it. Lithium-Ion battery technology creates small batteries that have lots of capacity. A commonly used battery is the 11.1 volt battery that fits inside a trailing box car along with all of the electronics. Another common method is to use a multi-unit consist with a dummy locomotive for the battery and the CONVRTR or *micro*AIRWIRE decoder. It is connected to the lead locomotive, and sometimes a 3rd locomotive that have the NMRA-DCC decoders already installed.

What battery voltage works best for G-Scale? What about HO scale?

The 14.8V lithium battery pack is what we offer and recommend for G-scale installations. It's the best compromise between motor generated noise and radio range. Fully charged, the pack is close to 17 volts and provides hours of operation although the actual time is dependent on the amount of current required by the locomotive. Higher voltages can be used but the motor will run hotter and will generate much more radio noise which will impact the reception range. For HO locomotives, an 11.1 volt lithium pack is recommended.

What Is Dead-Rail?

This relatively new phrase is used to described railroad track that is not connected to any power source. Instead, trains run on self-contained batteries. Adopting "dead rail" for your railroad eliminates the frustration and back-breaking effort of track wiring, track cleaning and locomotive wheel cleaning.

Will you install AIRWIRE in my locomotive for me?

No, CVP doesn't do installations. Fortunately, most of our dealers do installation. They have lots of experience and can install an AirWire decoder and battery into almost any locomotive or scale. Go to the AirWire section of the website and click on Dealer Listing.

CVP Products P.O. Box 835772 Richardson, TX 75083-5772
www.cvpusa.com 972-238-9966 info@cvpusa.com



Plug-In, Drop-In, AirWire, AirWire900, AIRWIRE, *micro*AIRWIRE, G3, CONVRTR and the AirWire logo are registered trademarks of CVP Products. © 2018 All Rights Reserved

AIRWIRE[®]

900

Battery Powered Wireless Control For Large And Small Scales

We Make "Dead-Rail" Possible!

All prices and specifications shown are subject to correction or change without notice

MADE IN THE USA

Look For This Symbol Marking
Exciting New Products

Designed, Manufactured and Serviced By CVP Products



AIRWIRE900®

Freedom To Enjoy Your Railroad!

- ☑ No Track Wiring
- ☑ No Track Cleaning!
- ☑ No Wheel Cleaning

CVP Product's **AIRWIRE900** system is a remote control system for all scales from G-scale to HO-scale and everything in between. **AIRWIRE900** system eliminates track power with onboard battery power. You control your train with a small handheld wireless throttle which provides simple and hassle free operation of your battery power locomotives.

AIRWIRE900 is simple. An **AIRWIRE900** system consists of a handheld controller, called a throttle, and a locomotive mounted motion-decoder powered by a modern, high-capacity battery. Each decoder equipped locomotive has a unique address, much like your house has an address, so the locomotive responds to throttle commands that have a matching address. Since there are 10,000 possible addresses, multiple trains can be controlled from a single throttle. The high-capacity and compact Lithium batteries provide several hours of uninterrupted operation.

Eliminate all track wiring. Battery power means there is no complicated track wiring for power delivery. Gone are all of the typical wiring nightmares *because the rail is dead!* Forget about wasting hundreds of hours soldering wires to rail. You'll save hundreds of hours of back-breaking labor.

Save money and using inexpensive track. There's no need to purchase expensive rail. Use the cheapest you can find including plastic rail. Gone are the expensive rail-clamps. And changing track plans is simple – just put down track and begin running immediately.

Uses safe battery power. There is no electrical power on the exposed track. No need to worry about electrical or shock hazards. Battery powered locomotives means never having to worry about electrical hazards and municipal electrical safety codes. This is important when children and pets are present.

Abolish track and wheel cleaning. Forget the endless hours of cleaning track and wheels. Your trains will run smoothly and reliably without hesitation or jerky performance. **AIRWIRE900** eliminates the need to clean the track and the locomotive wheels because the locomotive carries its own power supply.

Locomotives ALWAYS run better. There is never any stalling or hesitation caused by dirty track, dirty sliders or dirty wheels. Damaged and pitted wheels are a thing of the past since they are no longer required to transfer power from the rails.



AIRWIRE900 Installation Accessories

Drop-In ALT Lighting Pigtail

For use on Drop-Ins that offer an ALT lighting socket. The pigtail includes the matching plug along with 24 inches of very flexible, multi-colored, 6-conductor ribbon wire.

ALT \$ 4



External Antenna Adapter Cable

Has 6 inches of miniature coaxial cable with a UFL plug one end and a REVSMA jack at the other end. The UFL plug matches the G3X decoder with external antenna socket, or any other "X" decoder or CONVRTR. Use this cable to match between the decoder and the reverse-SMA type connector, like the dome antenna listed below.

UFLADAPT \$6



External Dome Kit

Low profile "dome" antenna. Can be painted with non-metallic paint. The dome is attached to 9 inches of RG174 coax cable and plug. Allows antenna to be placed external of car or locomotive for improved reception. Requires the UFL adapter cable.

Dome Style External Antenna Kit [DCA] \$25.95



Adapter Board For Aristo Locomotive's DCC/RC Socket

This plug-in adapter plugs directly into all Aristo locomotives having the DCC/RC Port (socket). It has clearly marked terminals and a self-resetting fuse to protect your battery pack.

Adapta-1K unassembled [requires simple soldering] \$ 19 each
 Adapta-1 fully assembled ready to use \$ 25 each



Wiring Kit For AUX Lighting Header On All Drop-Ins

Includes prewired plug with 12 inches of attached red/black wire to allow easy hookup of the AUX lighting header on all Drop-In Decoders. Easily add unique lighting effects for a truly custom look to your USA-Trains locomotive.

KK2 Wiring Kit \$ 3.75 each



Wiring Kit For Ditchlight Header on SD40 Drop-In

Includes prewired plug with 24 inches of attached 3-conductor wire to allow easy hookup of the Ditchlight header found on the SD40 Drop-In decoder. Just add your favorite white LEDs and enjoy the realism of working ditchlights.

KK3 Wiring Kit \$ 9.95 each



JST 2.5mm Plug or Socket

The SKT is the matching socket for the CVP battery pack plug. The PLUG is the same as found on the CVP battery pack. Each connector includes 12 inches of flexible red and black stranded wire.

JST-SKT \$ 1.25 each

JST-PLUG \$ 1.25 each



Plug To Fit Drop-In Charging Jack

Fits the battery charging jack on the bottom of the Drop-In decoder. Right angle plug, 2.1mm ID, includes 6 inches of polarity coded wire with ends stripped and tinned.

DICP \$ 4.95



14.8V 6.8Ah Battery Pack

Rated at 6.8A continuous discharge with a 14A peak discharge, this pack is ideal for the high current dual motors found in the USA-Trains diesels. It can power a USA-Trains SD70 for as more than 3 hours.

With its built-in protection circuitry and its automatic cutoff at the end of the charge, this battery offers long life, high capacity and nearly constant output voltage over the life of the charge. The dimensions are 2.9 x 2.8 x 1.5 inches. It weighs about 16 ounces and comes with a pre-mounted connector to match CVP's Plug-In and the USA-Trains Drop-In decoders.



BAT2
\$99*

14.8V 3.4Ah Battery Pack - "The Brick"

Rated at 4.9A continuous discharge with a 6A peak discharge, this small pack is ideal for locomotives with limited space. It easily fits the USA-Trains NW2 switcher, the S4 switcher and Bachmann's C19 steam engine.

With its built-in protection circuitry and its automatic cutoff at the end of the charge, this battery offers long life, high capacity and nearly constant output voltage over the life of the charge. The dimensions are 2.75 x 1.46 x 1.46 inches. It weighs about 8 ounces and comes with a pre-mounted connector to match the CVP's Plug-In and USA-Trains Drop-In decoders.



BAT3
\$65*

Smart Lithium Battery Charger

The charger works off any household line voltage from 90 to 240V 50/60Hz. The line cord is included. It features a 1.5A constant charging current for faster charging. It can charge a 6.8Ah battery pack in less than 4 hours. The built in microprocessor will automatically cut off power when the battery is fully charged. Indicator lights show red when charging and green with the battery is fully charged.



CHARGER1 Smart Charger for 14.8V Lithium Packs \$26

Higher amp-hour capacity batteries may be used although as capacity goes up, so does the price, the size, the weight and the need for a specialized charger. If these factors are less important than battery life, by all means use the higher capacity batteries. Be sure to obtain a matching charger and for best operation, stay with the 14.8V rating.

Check the CVP website for other batteries that may have been added after the printing of this catalog. From the home page, click on the AIRWIRE900 box and click on the "Batteries and Chargers" link.
www.cvpusa.com

*Not available for direct international shipment

To begin using **AIRWIRE900** with your trains, here are the 3 basic items you will need to convert your favorite locomotive into an **AIRWIRE900** wirelessly controlled, battery powered locomotive.

1 An AIRWIRE900 Decoder is needed if your locomotive doesn't have a decoder. There are several styles available. Some AirWire decoders are designed to fit into specific locomotives and use the locomotive's existing factory wiring. Other decoders plug into the locomotives built-in DCC/RC socket. For locomotives without a specifically designed **AIRWIRE900** decoder or DCC socket, use the generic G3 decoder with 120 Watts of power or the very small *micro*Decoder designed for HO scales.



G3 120W Decoder

If your locomotive already has a built-in NMRA-DCC decoder, or you want to install a 3rd party DCC sound plus motion decoder, then you will need an **AIRWIRE900 CONVRTR™**. The CONVRTR comes in 3 different amperage ratings; 1.5A, 2.5A and 6.0A. The CONVRTR series allows any NMRA-DCC compliant decoder to be setup and operated from an **AIRWIRE900** wireless throttle. No 3rd party DCC systems are required for any **AIRWIRE900** installation.



C15X CONVRTR™

2 An AIRWIRE900 T5000 throttle is required. The throttle is used to setup the locomotive's decoder to suit your particular operating requirements. The same throttle is also used to run the locomotive. The T1300 Operations Throttle (abbreviated to OPS) can also be used to run the locomotives. It is simple to use and very rugged - a perfect match for your enthusiastic, youthful operators. No other systems are required to setup or operate your **AIRWIRE900** equipped locomotive fleet.



T5000 Wireless Throttle

3 A Lithium-Ion rechargeable battery and battery charger are needed. CVP sells two of the most popular battery sizes used for the larger scales, the BAT2 and BAT3 both rated at 14.8V. These are used in most O-scale and G-scale installations. Fortunately, **AIRWIRE900** decoders can use just about any brand or type of battery. Battery sources for smaller scales are discussed in the back of the C15 CONVRTR User Guide. Download this user guide, or any CVP manual from the CVP website. www.cvpusa.com



BAT3 Lithium-Ion Battery

Changing over to battery power and AIRWIRE900 is not difficult. But, there are some considerations and decisions to make. If this is your first time to use battery power, the tip below will save you a lot of time and effort. It will also insure your very first installation is a first-time success.

Carefully Choose Your First Locomotive: Although this might be somewhat obvious, here are two very important tips to consider when starting your first installation.

Pick a locomotive that has plenty of space to hold the battery and the decoder. Don't select the smallest locomotive in your fleet since it will provide you with the biggest challenge - finding space. Also, it is OK to use a dummy locomotive or a trailing box car to hold the battery and the decoder.

Read and Follow The Installation Guide. It is said that a smart person reads the instruction manuals. However, we have found that a true genius is a person that not only reads the manual, they follow the instructions.



Getting Started - Smaller Scales

A **Battery Powered HO Locomotive With Wireless Control** has been an unfulfilled dream for many years. Fortunately, advanced technology has provided the small batteries and miniature radio receivers to make this dream a reality. And with locomotives already having factory installed DCC decoders, converting to **AIRWIRE900** battery power is relatively easy.

The diagram shows how easy it is to hookup a factory installed DCC decoder to the **AIRWIRE900 C15 CONVRTR™**. Start by locating the track pickup wires. Disconnect the decoder's track pickups from the wheels, and wipers. Connect the decoder's track pickups directly to the C15 CONVRTR output. Connect the battery to the CONVRTR battery input. There are no other changes to the decoder wiring.

Select the largest battery to fit the space available. For very long runtimes, you may wish to mount the battery and the CONVRTR into a trailing box car or dummy locomotive for an easy change out. Only two wires are needed between the loco and the battery car.

The diagram also applies to a locomotive that requires the installation of a 3rd party DCC decoder. Always select both the decoder and the CONVRTR based on the locomotive motor's amperage. For most HO locomotives, a 1.0A DCC decoder paired with the C15 CONVRTR makes an ideal solution.

Also see page 11 for a more detailed description of the CONVRTR series along with additional selection tips. The complete CONVRTR series is shown on page 12.

Typical CONVRTR™ Hookup For HO Scale

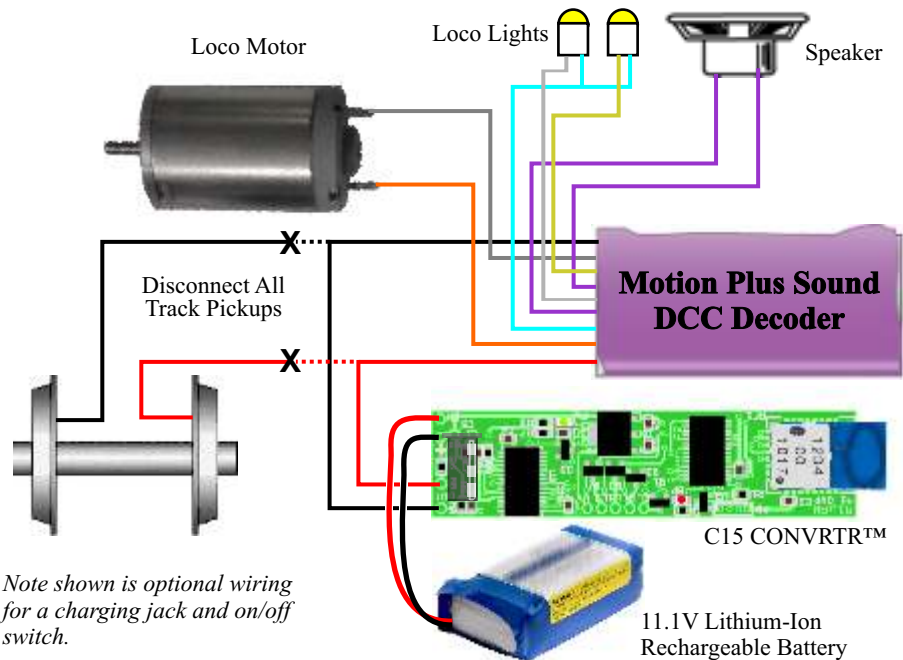

Note shown is optional wiring for a charging jack and on/off switch.

Not Sure Of Your Installation Skills?

If you would rather have somebody else do the installation, check the CVP website for the AirWire dealer directory. Nearly all dealers offer installation services. Give them a call, they will be happy to install AirWire into your favorite locomotive.

TURNOUT & ACCESSORY CONTROL

LINKER and ACTIVATOR



Remote control of turnouts and many types of accessories is easily accomplished with the combination of a single **AIRWIRE Linker** and one or more **AIRWIRE Activators**. Together, the Linker and Activator allow your wireless throttle to control items such as switch machines, lights, pumps, relays, solenoids or just about any other type of device found on a typical garden railroad.

The Linker

A basic setup consists of a Linker, which is the radio receiver, plus a power supply (battery or adapter) and the Activator which controls the turnouts or accessories. Each Activator can control 4 independent turnouts or accessories.

The Linker scans all **AIRWIRE** frequencies and combines the received activation commands with DC power and sends the combined signal to the companion Activators using a single pair of wires. The Linker can use either a 14.8V battery or a 15VDC power supply like the DCPS120 power supply.

All setup and option selection is done with the front panel switches. The 4 switches allow for selecting the scanned frequencies or to lock out certain frequencies.

All wire connections to the Linker are through plug-in terminal blocks. All wires can be connected or disconnected at one time by simply plugging or unplugging. Multiple Linkers can be used on a large railroad where there is a large distance between clusters of turnouts. Only a single Linker is needed to control and supply power to as many as 25 Activators.

The Activator

The Activator uses a single pair of wires, that connects it back to the Linker's DCC output. Multiple Activators can share the Linker's output. No power supply is needed. Power for the Activator comes directly from the Linker. All Activators share the same pair of wires and power source coming from the Linker.

The Activator can control four independent accessories such as switch machines. It can also control lights, signals, stationary motors, pumps and relays. The Activator is compatible with all types of switch machine motors including air-actuated machines. It can also control power relays and solenoids.

The Activator can be purchase in a custom plastic case with removable plug blocks. It is also available without the case and standard screw terminal strips.

- Linker - AWLK** \$149^{1,2,3,4}
- Activator - with case AWACT** \$119^{2,3}
- Activator - without case AWACTX** \$99
- DCPS120 Power Supply** \$55^{2,3}

1-Works with all AIRWIRE Throttles
3-Prices subject to change without notice

2-MSRP excluding shipping and handling
4- Battery or Power Supply not included

CONVRTRs™

Makes NMRA-DCC Decoders
AirWire Compatible!

1.5 Amp Rating - CONVRTR-15

Includes a radio module with a built-in onboard antenna. It is rated at 1.5A continuous and 5A peak. Maximum input voltage is 18 volts. The circuit board measures only 2.4 inches long and 0.6 inches wide.

The X version has an antenna jack for use with the included 3-inch long whip antenna. An optional external adapter cable allows the use of other types of antennas.

CONVRTR-15 \$89
CONVRTR-15X \$95

CONVRTR-15 Internal Antenna

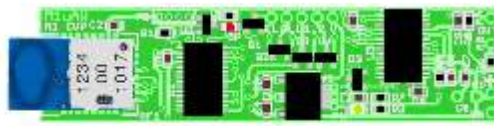

CONVRTR-15X External Antenna

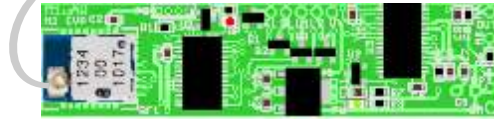

2.5 Amp Rating - CONVRTR-25

With a built-in onboard antenna, and a rating of 2.5 amps continuous, this little AirWire model has the entire radio receiver and DCC booster driver all built onto a circuit board that measures only 2 inches long and 0.9 inches wide. The maximum input voltage is 18 volts.

The X version has an antenna jack for use with the included 3-inch long whip antenna. An optional external adapter cable allows the use of other types of antennas.

CONVRTR-25 \$99
CONVRTR-25X \$105

CONVRTR-25 Shown Actual Size



CONVRTR-25X Shown Actual Size



6 Amp Rating - CONVRTR-60

Onboard Antenna Version: With a built-in onboard antenna, and a rating of 6 amps continuous and 55 amps surge, this is our most powerful CONVRTR. It includes the AirWire radio receiver plus the high power DCC booster driver.

All connections are made to the convenient terminal strips (not shown).

It is protected against overvoltage, overcurrent and thermal overload. The circuit board measures only 2.2 inches long and 1.2 inches wide.

The maximum input voltage is 24 volts.

The X version has an antenna jack for use with the included 3-inch long whip antenna. An optional external adapter cable allows the use of other types of antennas.

CONVRTR-60 \$132
CONVRTR-60X \$138

CONVRTR-60 Shown Actual Size

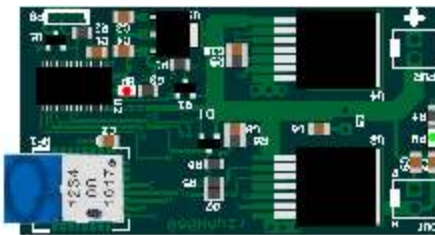

CONVRTR-60X Shown Actual Size

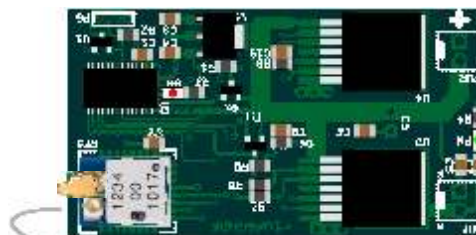

DECODERS

The G3™



The G3 decoder is a complete, self-contained radio receiver and motion decoder that offers both small size and big power that fits most brands of locomotives. It is the 3rd generation of our popular decoder series and features many novel and often requested features.

The heart of the G3 decoder is a powerful motor driver circuit suitable for locomotives having multiple motors. It has an enormous power capacity of 120 Watts, making it suitable for all large scale locomotives.

A 2.5amp DCC booster is built-in to provide power and command signals for NMRA-DCC sound decoders. Other types of NMRA-DCC decoders such as multi-function decoders, are also compatible.

There are two basic models of the G3 decoder. Model number G3 has a built-in circuit board antenna. Model number G3X has a flexible whip antenna. Both of these models can be ordered with or without terminal strips.

For small locomotives, the G3 without terminal strips reduces the height considerably. It's a favorite for use in small switchers and steam engine tenders. Wires are soldered directly to the circuit board in the locations normally occupied by the terminal strips.

- ▶ Small size, only 1.4in x 4.0in
- ▶ Frequency Set From Throttle
- ▶ 17 Independent Radio Frequencies
- ▶ Easy Speed Matching
- ▶ Smooth, Quiet, Precision Drive
- ▶ 120W Motor Driver
- ▶ Easy Fine Tuning of motor
- ▶ Outstanding Cruise Control
- ▶ Ditch/Safety Lights Driver
- ▶ High Power Smoke Generator Driver
- ▶ 16 Special Lighting Effects
- ▶ Available With Internal Or Whip Antenna
- ▶ Easy-to-use Terminal Strips
- ▶ Automatic Rule-17 dimming
- ▶ Works with all NMRA-DCC sound decoders
- ▶ Printed, comprehensive User's Guide included

Both models available
without terminal strips

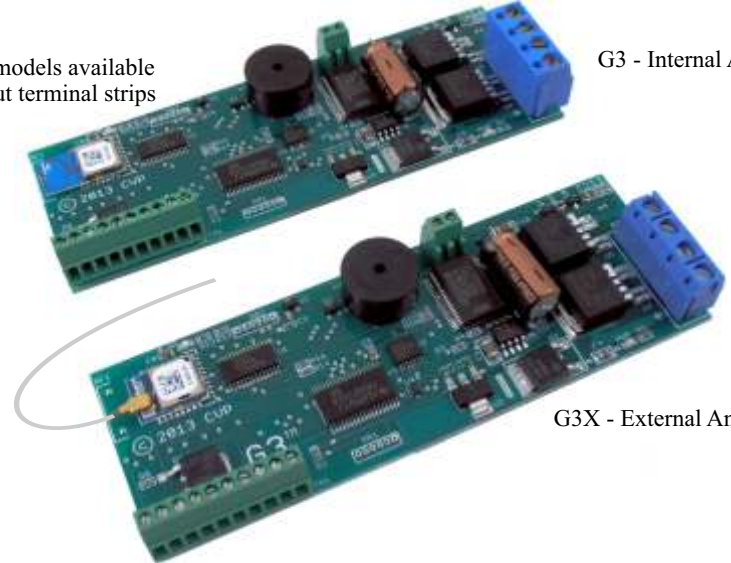

G3 - Internal Antenna

G3X - External Antenna Model

G3N Motion decoder with internal antenna but without terminal blocks \$132
G3 Motion decoder with internal antenna and with terminal blocks \$136
G3XN Motion decoder with external whip antenna but without terminal blocks \$145
G3X Motion decoder with external antenna and with terminal blocks \$149

DECODERS K27/C19 PLUG-IN™

The new Plug-In Series AirWire decoders are designed to fit the DCC/RC socket found in newer locomotives like the **Bachmann K27 and C19** steam locomotives. The new Plug-In decoder plugs directly into the existing socket. No rewiring of the locomotive is necessary. Included on the decoder are sockets to plug in the optional Phoenix P8 sound module and two of the optional Phoenix remote couplers.



- ▶ Plug-in simplicity - Uses Factory DCC Socket
- ▶ Includes Drivers For optional Phoenix Couplers
- ▶ Socket for Phoenix P8 Sound Module
- ▶ Control All P8 Sound Functions
- ▶ Built-in Battery Charging Jack
- ▶ Remotely Select 17 Radio Frequencies
- ▶ 120 Watt Protected Motor Drive
- ▶ 3A Smoke Driver With Programmable Shutoff

\$149

DECODERS DROP-INS™

The **USA-Trains Drop-In Decoders** are designed for specific locomotives made by USA-Trains. These decoders are not shown actual size and some wiring harnesses are not shown. Drop-Ins can fit other locomotives too although the wiring might be slightly different. Download the individual Drop-In installation guide to learn how easy it is to install the Drop-In Decoder.

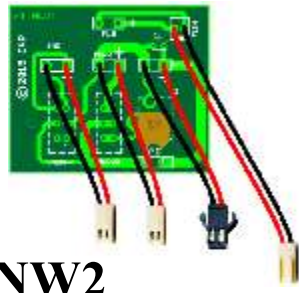

- ▶ Two separate circuit boards for proper positioning and easier installation
- ▶ Wiring Harnesses Included For PC Board Hookup
- ▶ Includes Drivers For Optional Phoenix Couplers
- ▶ Plug In Optional Phoenix P8 Sound Module
- ▶ Built-in Battery Charging Jack Under Front Radiator Grill
- ▶ Separate Switches For Sound and Decoder Power Under Front Grill
- ▶ Remotely Select 17 Independent Radio Frequencies
- ▶ 120 Watt Protected Motor Drive With Precision Speed Control
- ▶ Battery Connector Matched to all CVP Batteries
- ▶ 3A Smoke Driver With Programmable Shutoff

NW2

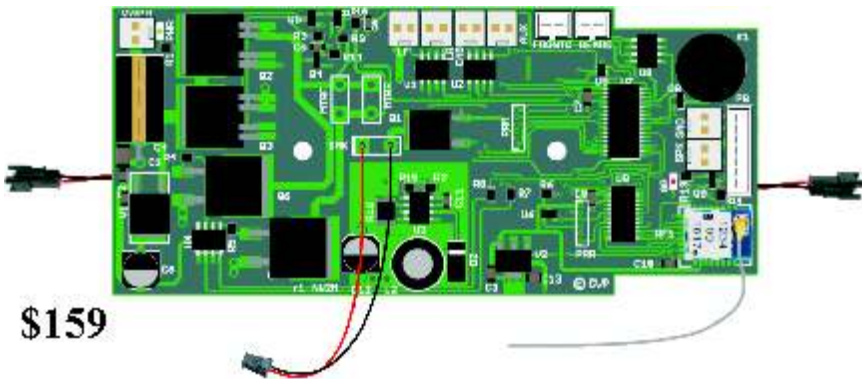

\$159

Turn the page for more Drop-In Decoder to fit other USA-Train Locomotives

CONVRTRs™ Makes NMRA-DCC Decoders AirWire Compatible!



Say Goodbye To Mr. Kilowatt

We Make Dead-Rail Possible!

The CONVRTR™ series of products, allows any NMRA-DCC compliant decoder to become an AirWire compatible decoder. Take advantage of the pre-installed DCC decoders found in a wide range of HO and larger scale locomotives. With the simple addition of a CONVRTR plus a battery, the locomotive becomes an AIRWIRE locomotive.

Each CONVRTR (Converter) is an ultraminiature radio receiver plus a powerful DCC booster. All of the attached decoder's features and functions are controlled directly from an AIRWIRE throttle. There are absolutely no changes to the decoder. In addition, an AIRWIRE throttle is used to setup and program the DCC decoder. There is no need to purchase any other equipment.

The CONVRTR series has 3 different sizes making it suitable nearly all scales. And battery operation has many benefits - probably more than you can imagine.

Enjoy freedom from all layout wiring. Complicated wiring, track busses, reversing loops, reversing sections, wyes, and all associated hardware is eliminated. Don't forget that expensive track boosters, distribution centers and hundreds of terminal blocks are no longer needed either.

Locomotives always run better with no hesitation or stalling. Thanks to on-board power, the locomotive always has a steady source of clean, constant power. The onboard radio receiver guarantees that a clean reliable signal is continuously delivered to the DCC decoder. The locomotive's performance is not affected by dirty track, dirty wheels, or lack of all wheel-pickup.

No Changes To The DCC Decoder are required to use a CONVRTR. Unlike other systems and methods, the DCC decoder connects directly to the CONVRTR without any modifications. Because of this, the decoder warranty remains valid when using the AirWire CONVRTR.

A Unique Feature Of The CONVRTR is the elimination of Stuck Horns or Whistles. If the locomotive goes out of range of the throttle while the horn or whistle is blowing, the CONVRTR will automatically command the decoder to turn off the horn or whistle. This handy feature is built-in and works automatically with all sound decoders.

Optimized For Sound + Motion DCC Decoders. Sound decoders have very high surge current requirements when first powered up. The CONVRTR allows for these very for these surge currents without triggering its built-in protection. Be assured that your CONVRTR will support nearly all of the presently available brands of NMRA-DCC compliant sound+motion decoders.

Selection of a CONVRTR is based on the required output amperage, the available space and type of radio antenna desired.

Locomotive Amperage is the first specification to consider. The actual scale of the locomotive doesn't matter. If the locomotive used more current than the CONVRTR is rated for, then the locomotive will overload the CONVRTR and not run. Beware of high stall current motors. As a heavily loaded motor slows down, the current demand increases. If the required current is in excess of the CONVRTR's rating, the protection circuit will trip and the locomotive will stop. *Note: A lower current locomotive can always be driven by a higher current CONVRTR.*

Available Space is the next consideration. Don't forget to include space for the battery when planning an installation.

Battery Voltage is the next consideration. The recommended battery voltages range between 11 and 24 volts. The CONVRTR-15 and the CONVRTR-25 are rated to handle up to 18V battery packs. The CONVRTR-60 is rated to handle up to 24 volts which allows the use of 22 volt battery packs.

The Antenna Option Is The Final Consideration. The standard version uses a radio module with a built-in internal antenna. This is perfect for small plastic tenders and other small plastic locomotives. For brass or metal locomotives, use the X version of the CONVRTR. It has a radio module with a miniature whip antenna. Stick the antenna out of the top, bottom or side of the metal shell for best range.

Simple Operation And Money Saving Features

This throttle is designed for simple and easy operation of your AirWire decoder equipped trains and accessories. The rugged design is perfect for youngsters and guests.

Sleek Comfortable Case

The classic tall skinny case has been specially designed for hours of operation. It is designed to fit the smaller hands of younger operators whether they be right or left handed. Add in the big knob and bright indicators and the OPS throttle is sure to be a hit with your operators. The case measures 1 inch thick, 6 inches tall and 2 inches wide.

Built-In Rechargeable Battery

A self-contained rechargeable battery saves you money. No need to spend money on expensive alkaline batteries. The large capacity battery provides more than 40 hours of continuous operation. An automatic power off feature shuts off the throttle after 15 minutes of non-use.

Flexible Charging Options

You can purchase a T1300 throttle with or without the charger and charging cable. Almost any USB charger can recharge the built-in battery. You can use the USB port in your car or, if you plan to have many OPS throttles, consider getting a USB multi-port charging hub. These are inexpensive and readily available. The recharging cable is a simple USB to microUSB adapter cable and it too is readily available.

Simple To Learn – Easier To Use

The OPS throttle uses simple key strokes to run the locomotive. Just push the green # key, followed by the locomotive number and conclude with the green key and drive away. That's it - there are no complicated menus or cumbersome stroke sequences to remember.

Rugged Classic Speed Control Knob

A conventional single turn speed control offers smooth yet precise control of your locomotive's speed and is rugged enough to withstand constant use and abuse from your young and young-at-heart operators.

20 Function Keys

Activate all of your favorite decoder functions. There are 20 function keys just a keystroke away. Plus, a new feature allows simultaneous control of your locomotive and all 20 function keys while controlling turnouts and accessories.

Designed For Operation – Not A Decoder Programmer

The OPS throttle can't program decoders so you will need at least one T5000 throttle for the programming task. But, once done, the T1300 OPS throttle can take it from there.

Download The User Guide And Learn All Of The T1300 Capabilities

The complete user guide is available for download from the CVP website.

www.cvpusa.com



Size: 6" x 2" x 1"



Universal charger for 90VAC to 240VAC



Charger Cable
Motor USB to microUSB

Pricing and Ordering Options

T1300-Combo	Throttle, charger and cable.....	\$ 139
T1300	Throttle alone, no charger or charger cable	\$ 129
Charger cable	Charger cable for use with 3rd party USB hubs.....	\$ 6

Just released is the redesigned Drop-In for USA-Trains GP7/9 and the USA-Trains PA-B and the S4 locomotives. The new Drop-In decoder makes installation not only easier, but the new GP7/9 can be configured for either the older style chassis lighting or the current production lighting. No need to rewire or change anything. This is an entirely new architecture featuring smooth reliable operation. The GP7 and the PA-B Drop-Ins also features a new ALT lighting expansion port for adding extra lighting with configurable lighting effects.



S4
GP7/9
PA-B

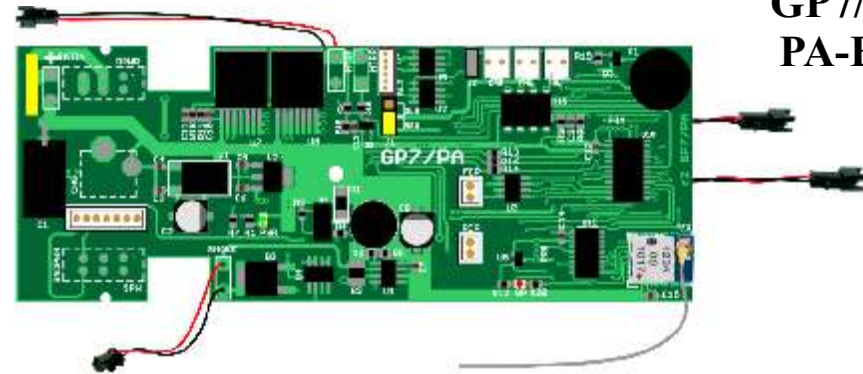

New Drop-In Architecture - New Features - New Benefits

- ▶ Uses Original Factory Wiring
- ▶ Selectable old or new style wiring
- ▶ Sockets for Optional Phoenix Couplers
- ▶ Socket for Phoenix P8 Sound Module
- ▶ Built-in Battery Charging Jack
- ▶ Power Switches For Sound and Decoder
- ▶ 17 Independent Radio Frequencies
- ▶ Remote Frequency Setting
- ▶ New Light Driver Outputs
- ▶ New Ditch Light Drivers
- ▶ 120 Watt Protected Motor Drive
- ▶ Easily Fine Tune Motor Performance
- ▶ Independent Control Of All Lighting
- ▶ 3A Smoke Driver With Shutoff Timer
- ▶ Control of All P8 Sound Functions
- ▶ Battery Connector For CVP Batteries
- ▶ Works With All AIRWIRE Throttles
- ▶ Updated Installation and User Guide

USA-Trains Drop-In Listing

GP7/9 Drop-In*	\$149
PA-B Drop-In*	\$149
S4 Drop-In*	\$149
NW2 Drop-In	\$159
SD40-2	\$139
GP30	\$139
F3A-B	\$139
SD70MAC	\$139
GP38-2	\$139

* Features New Architecture

Each Drop-In decoder comes with a pre-installed battery connector that matches the CVP battery. Some Drop-Ins include an additional extension cable where the factory wiring was found to be too short or inadequate.

Discover how easy it is to install a Drop-In. Download the Drop-In installation manual for your USA-Trains locomotive.

Your Loco Not Listed? Use The G3 Decoder!
The G3 decoder is small enough to fit almost any USA-Trains locomotive yet it has the same power rating as the Drop-In decoders. The G3 decoder is described on page 5.

DECODERS *microDecoder*™

AIRWIRE Motion Decoders Small Enough For HO scale!

From the acknowledged experts in wireless, battery powered model railroading, comes a new series of AIRWIRE decoders small enough for HO scale.

Using onboard batteries makes railroading fun again. Imagine no layout wiring, no reverse loop nightmares, and no track or wheel cleaning. Best of all, a stuttering or constantly stalling locomotive will run smoothly since it no longer relies on its poor pickups and wheels for power.

More importantly, there is no need to purchase additional DCC programming equipment because our most popular T5000 AirWire throttle is also a complete, self-contained DCC programmer. Use the T5000 to easily select and setup all of the decoder's options and fine tune its operation.

μAWM15 1.5Amp *microDecoder*

- Radio Receiver and DCC Motion Decoder
- 1.5A Continuous, 5A Peak
- Protected Against Overloads & Overheating
- 17 User Selectable Frequencies
- 9999 Addresses per Frequency
- Front & Rear Headlight + 2 Aux LED drivers
- Lighting Effects and Headlight Direction Modes
- 10V to 18V Battery Range
- Precision Motor Drive With Cruise Control
- Select Either Internal Or External Antenna

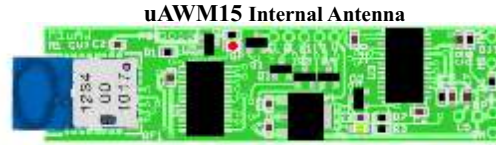

Actual Size! 0.6 x 2.4 x 0.25 inches



Pricing and Options

- uAWM15 (internal antenna) \$ 89
- uAWM15X (external antenna) \$ 95

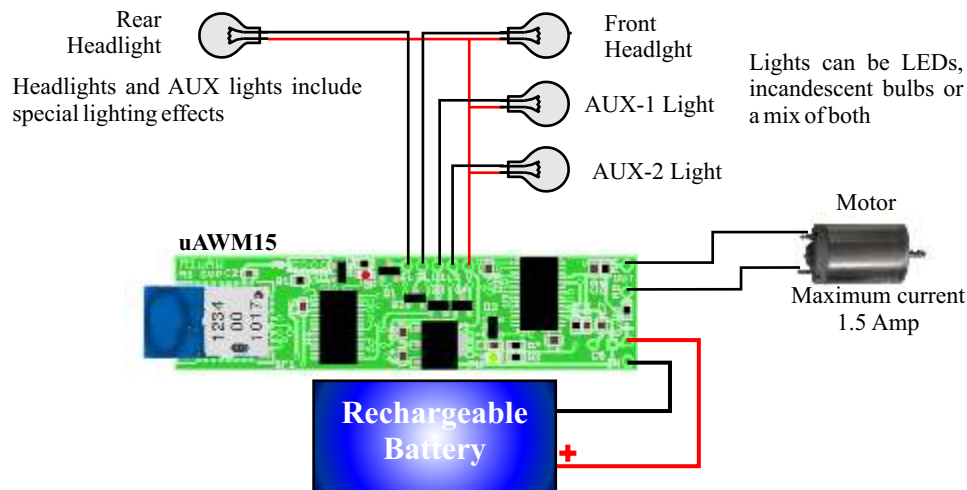

A 3.7V single cell plus a 12V boost circuit is also suitable. See the microDecoder users manual for more information on batteries, boost circuits and sources.

THROTTLES **T5000**™

Our Most Popular Wireless Throttle



Easy to Use - The T5000 wireless throttle establishes a whole new category for a value priced and easy to use throttle. This is our 3rd generation throttle and we have taken to heart all of the compliments and critiques of our other throttles. You will enjoy all of the added improvements and refinements at a price that is well within your budget. The result: a superb hand held wireless throttle that is value-priced, affordable, capable and rugged.

Built-In DCC Decoder Programmer - Inside the T5000, is a complete DCC decoder programmer. Any NMRA-DCC compatible decoder can be programmed when connected to our DCC outputs such as found on the G3 motion decoder and the popular CONVRTR. With the T5000 throttle, you can program any of the more than 1000 configuration variables found in modern DCC decoders. This is especially handy when using complex sound decoders.

Big, Bold Display - No need to decipher strange symbols. The locomotive number, speed and direction are clearly shown in easy to see characters. Also check the frequency and the battery status without any key pushes.

Backlight Option - If you operate at night, you might like the new T5000B which includes a built-in display backlight that you can turn on and off using the keyboard. Use of a white LED backlight keeps power consumption low to preserve battery life.

Menu Page 1

- 0. OPS PROGRAM
- 1. POWER OFF
- 2. SS SELECT
- 3. FREQ SELECT

Menu Page 2

- 4. SVC PROGRAM
- 5. AUTO OFF TIMER
- 6. TRANSMIT POWER
- 7. FACTORY RESET

Consist Building

CONS **6345**
BUILD CONSIST?
* ESC ENT *

Set Transmit Power

POWER **--**
LEVEL **--**
* ESC ENT #

- Fast and simple locomotive setup
- Dedicated buttons for common features
- Long range internal antenna
- Auto shut off timer from 1-9999 minutes
- 28 DCC functions
- 17 radio frequencies and no external antenna

- 11 user selectable transmit power levels
- Works with all AirWire decoders
- Needs only 2 AAA batteries
- 4.3in tall, 2.5in wide, and 0.75 in deep
- Backlight version for use at night
- Optional clip for belt or lanyard use

- T5000 Wireless Throttle [without backlight] \$159^{1,2}
- T5000B Wireless Throttle with built in backlight. \$179^{1,2}
- Belt Clip Includes mounting screws \$6²

1-Available in the Americas, Canada and Japan 2-MSRP excluding shipping and handling